

PHILIPS

hue personal
wireless
lighting

Attract



HUE serial number



User manual
Benutzerhandbuch
Notice d'emploi
Manual de usuario
Manual do usuário
Manuale d'uso

Incl.

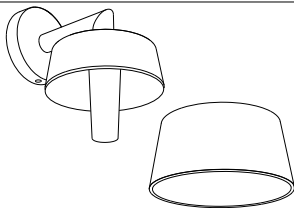

Excl.

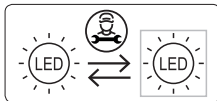
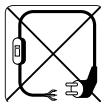
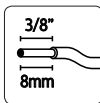
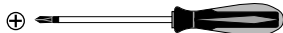
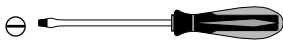
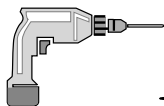

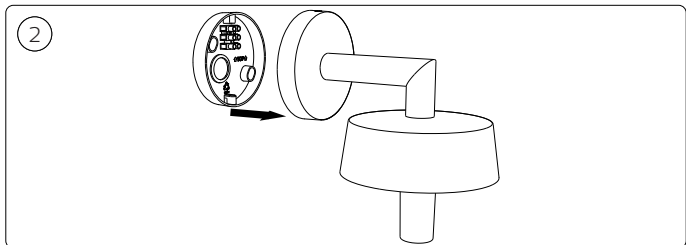
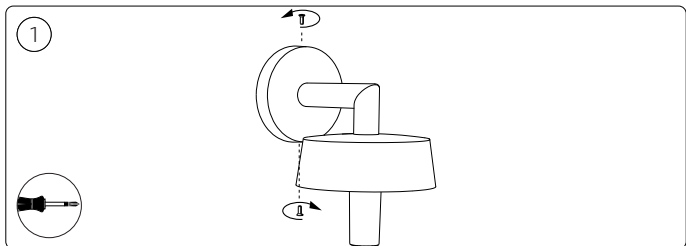
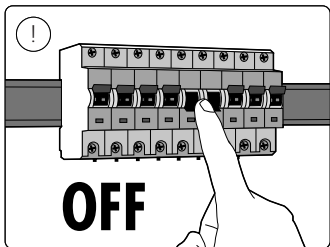
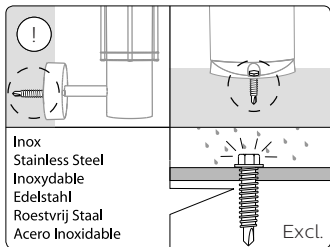

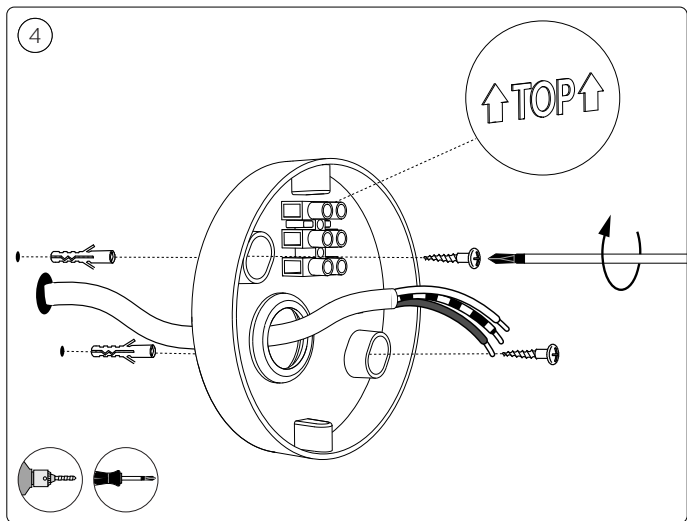
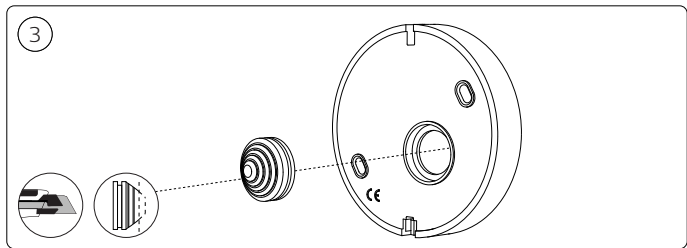

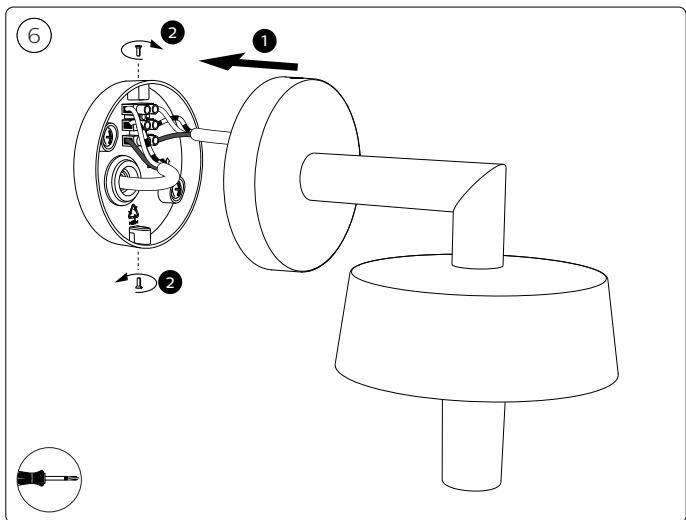
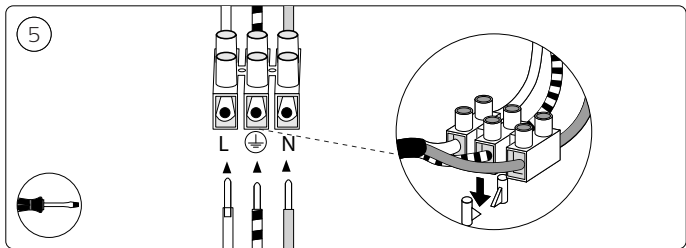

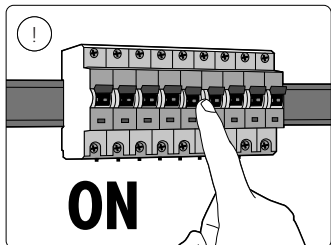
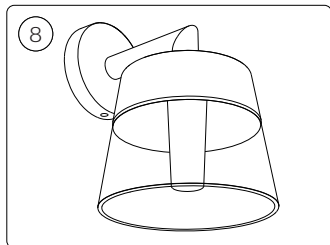
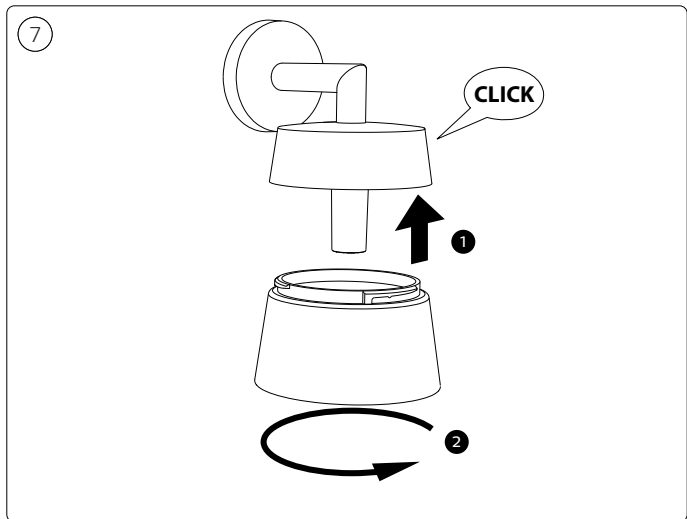

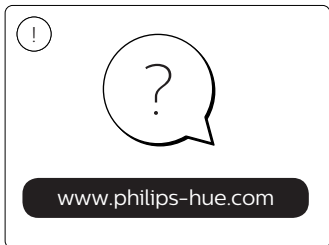
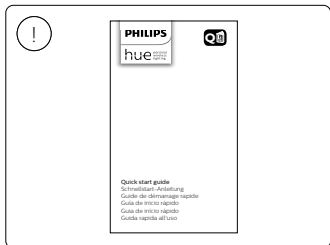
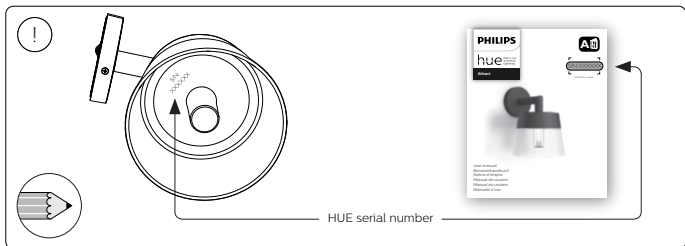
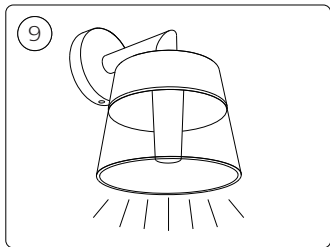



Signify
I.B.R.S. / C.C.R.I. Numéro 10461
5600 VB Eindhoven,
the Netherlands
☎00800-74454775

© 2021 Signify Holding
All rights reserved

www.philips-hue.com

17461/**/P7
4404 029 11952
Last update: 04/2021